



BRUTE™

by



Illustrated Parts List

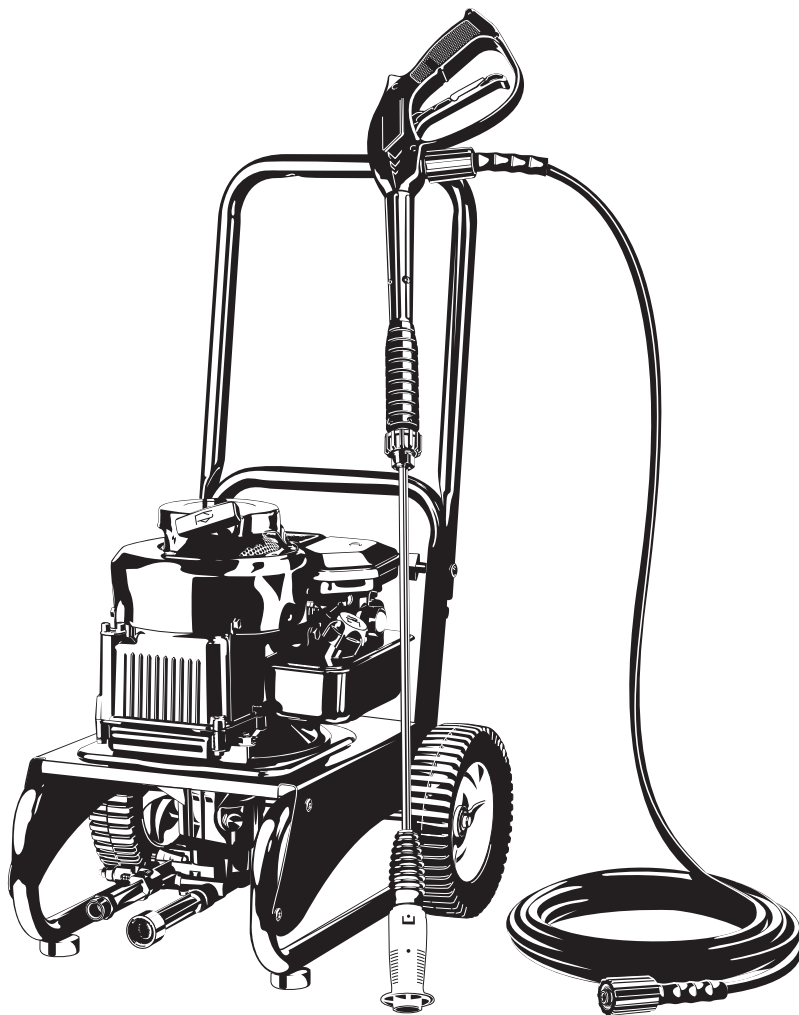

Questions? Help is just a moment away!

Call: **Pressure Washer Helpline**

1-800-743-4115 M-F 8-5 CT

BRIGGS & STRATTON POWER PRODUCTS GROUP, LLC
JEFFERSON, WISCONSIN, U.S.A.

Model No. 020290 (2000 PSI Pressure Washer) Manual No. 201624A Revision - (09/27/2006)

Exploded View and Parts list — Main Unit

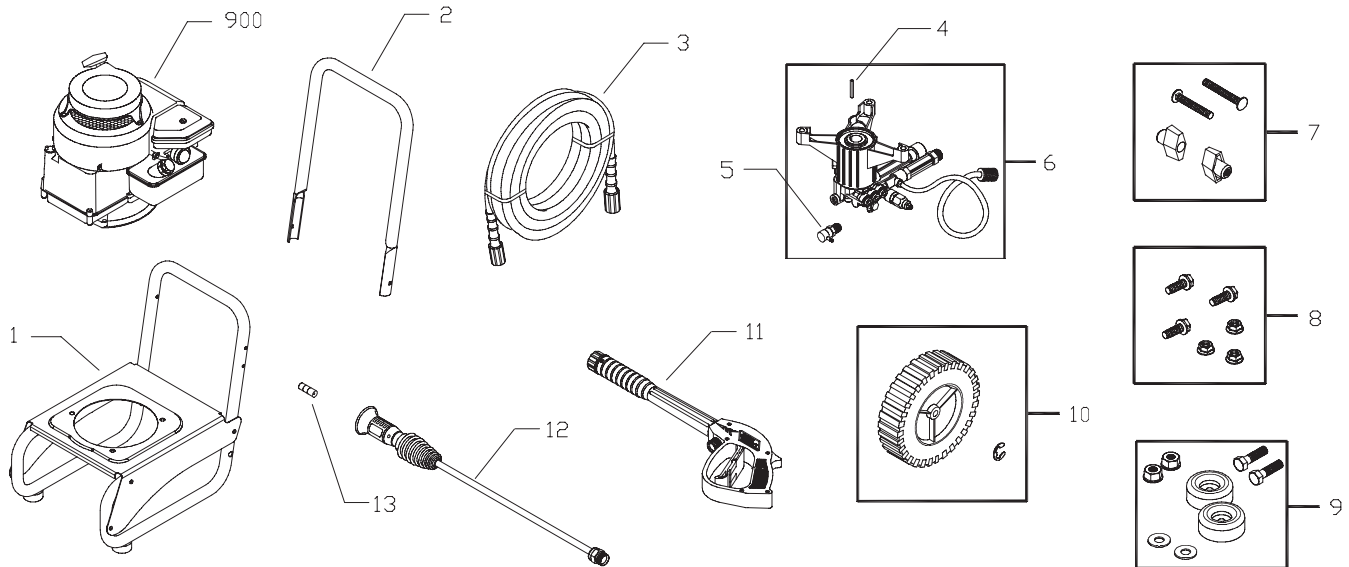

Item	Part #	Description
1	201625GS	ASSY, Base
2	B195960GS	HANDLE
3	196006GS	HOSE
4	23139GS	KEY
5	194298GS	THERMAL RELIEF
6	200303GS	ASSY, Pump
7	B2203GS	KIT, Fastening Handle
8	200199GS	KIT, Pump/Engine Mounting Hardware
9	198766GS	KIT, Vibration Mount
10	201643GS	KIT, Wheel
11	193482GS	GUN
12	194344DGS	WAND
13	193609DGS	ORIFICE
900	§	ENGINE

§ - Contact Engine Manufacturer

Items Not Illustrated:

201624GS	MANUAL, Operator's
BB3061BGS	OIL BOTTLE
87815GS	GOGGLES
275034GS	LABEL, Warning
192050GS	E-RING
201550GS	AXLE, Wheel
201642GS	KIT, Decal, Srv

Optional Accessories

5041D	STABILIZER, Fuel
100516GS	KIT, O-Ring
6039	PUMP SAVER

Copyright © 2006 Briggs & Stratton Power Products Group, LLC. All rights reserved. No part of this material may be reproduced or transmitted in any form by any means without the express written permission of Briggs & Stratton Power Products Group, LLC.

Exploded View and Parts List — Pump

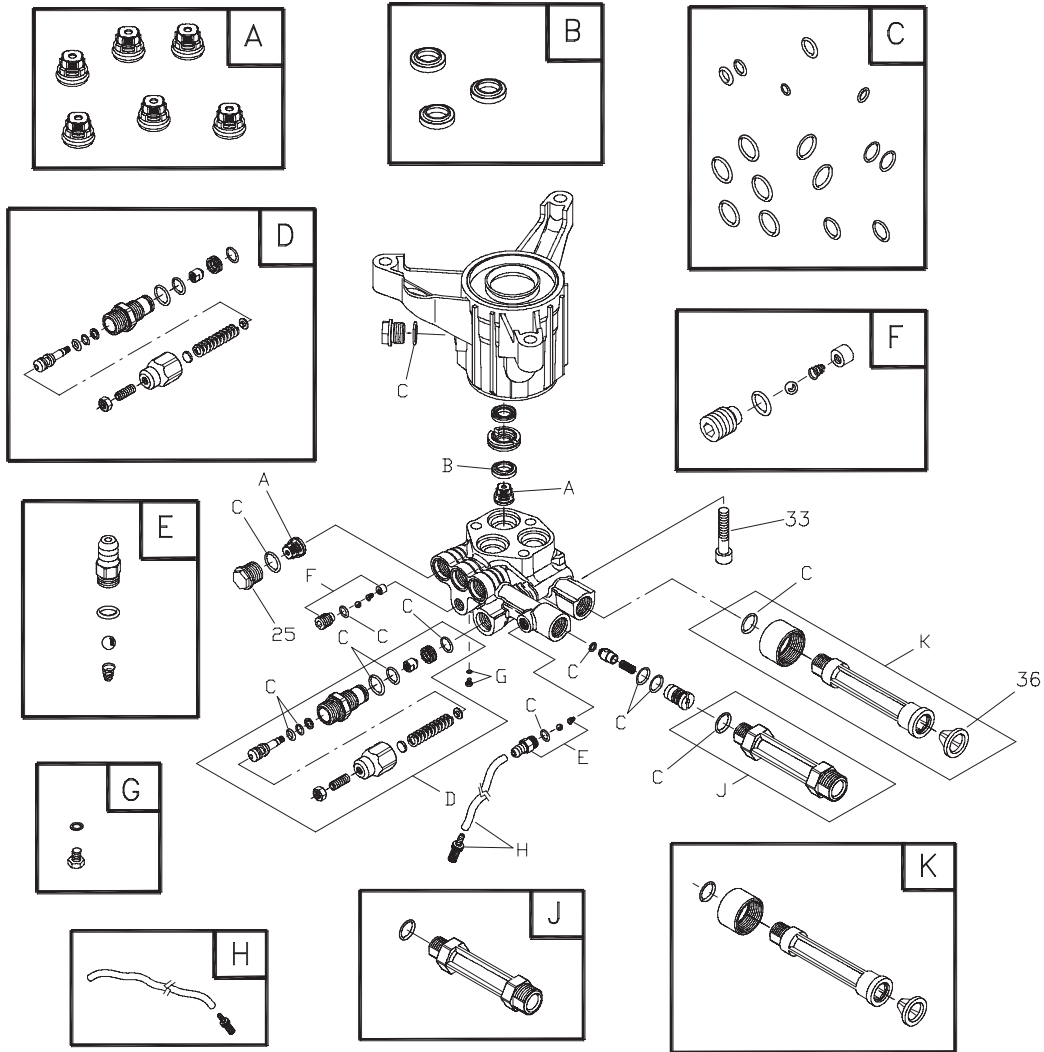

Item	Part #	Description
25	201495GS	PLUG
33	200275GS	SCREW
36	B2384GS	FILTER, Inlet
A	200344GS	KIT, VALVES
B	200345GS	KIT, WATER SEALS
C	200346GS	KIT, O-RINGS
D	200348GS	KIT, UNLOADER
E	192914GS	KIT, HOSE TAIL
F	200349GS	KIT, EZ START
G	200350GS	KIT, GRUB SCREW & WASHER
H	189971GS	KIT, CHEMICAL HOSE
J	201497GS	KIT, OUTLET
K	201496GS	KIT, WATER INLET

Parts Not Illustrated	
194298GS	THERMAL RELIEF

Optional Accessories	
6039	PUMP SAVER
186452GS	FILTER, Inlet Bag of 10
6033	OIL BOTTLE, Pump

NOTE: Item letters A - K are service kits and include all parts shown within the box.